

## SC6.3 Cultural heritage planning scheme policy

### SC6.3.1 Introduction

Short Title -The planning scheme policy (PSP) may be cited as the Cultural heritage PSP.

#### SC6.3.1.1 Purpose

The purpose of the planning scheme policy is to provide applicants with additional information and guidance in meeting the requirements of the [Cultural heritage overlay code](#) and the [Advertising devices code](#) for signage in Flinders Street East.

#### SC6.3.1.2 Legislative authority

This planning scheme policy is made under Chapter 2, Part 3 of the [Planning Act 2016](#).

#### SC6.3.1.3 Relationship to the Townsville City Plan

This planning scheme policy is to be read in conjunction with the assessment provisions specified in the Townsville City Plan, specifically the [Cultural heritage overlay code](#) and [Advertising devices code](#).

#### SC6.3.1.4 Terminology

Terms used in this planning scheme policy are defined in [Schedule 1 – Definitions](#). A term used in the planning scheme policy which is not defined in Schedule 1 – Definitions, is to be interpreted in accordance with [Part 1.3.1](#).

### SC6.3.2 Planning scheme policy details

The cultural heritage of Townsville continues to be a major contributor to the identity of the City and local communities. The [Citation of Heritage Places Report](#) provides information about each heritage place in Townsville. It highlights the criteria that were originally identified for each place and indicates its significant heritage features and eligibility for entry into [Schedule 7 Places of cultural heritage value](#).

This planning scheme policy contains information to help individuals and groups identify, conserve and protect heritage places in Townsville. This policy provides applicants with guidance in meeting the requirements of the Cultural heritage overlay code and the [Advertising devices code](#) (where it relates to advertising devices for heritage places in Flinders Street East). The policy also details how to nominate to add a place to Schedule 7 Places of cultural heritage value and how to nominate to remove a place from Schedule 7 Places of cultural heritage value.

#### SC6.3.2.1 Finding your way around the policy

The policy is divided into the following nine sections:

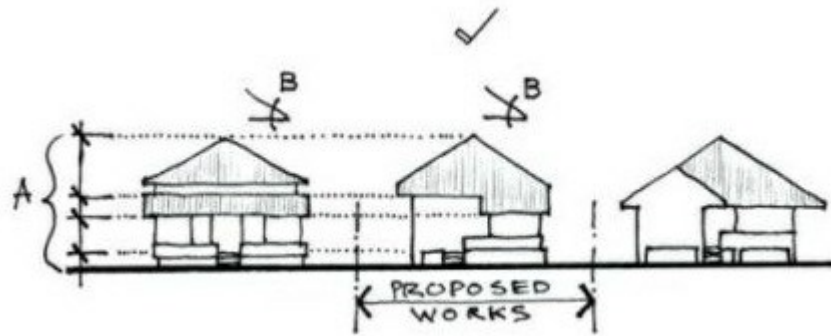
- (1) Information that may support a development proposal (SC6.3.3);
- (2) Development adjoining a heritage place (SC6.3.4);
- (3) Development within a heritage place, including advertising devices (SC6.3.5);
- (4) Preparing a heritage impact statement report (SC6.3.6);
- (5) Preparing a condition report (SC6.3.7);
- (6) Preparing archival recording of a heritage place (SC6.3.8);
- (7) Interpretive signage for the loss of a heritage place (SC6.3.8.3);
- (8) Preparing an archaeological management plan (SC6.3.9); and
- (9) Adding or removing a place to Schedule 7 Places of cultural heritage value (SC6.3.10).

### SC6.3.3 Information that may support a development proposal

The information required for any development application will depend on the heritage significance of the heritage building, site or element and the proposed development. In addition to the requirements for development applications under the [Planning Act 2016](#) (PA) and the relevant [Integrated Development Assessment System forms](#), the following additional information should generally be provided to council.

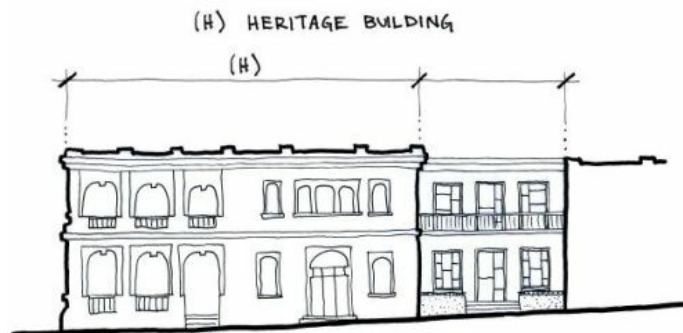
- (1) To ensure that the design of the proposed development is undertaken with a clear understanding of the surrounding context and significance of "place", the proposed application should submit clear representations of the relationship between the heritage buildings and the proposed works.
- (2) The applicant should submit a street elevation of the proposed development. The elevation is to be

- (a) drawn to 1:200 scale;
- (b) include the full width of the street frontage of the proposed development and the two adjacent neighbouring buildings (as shown in Figure SC6.3.3.1);



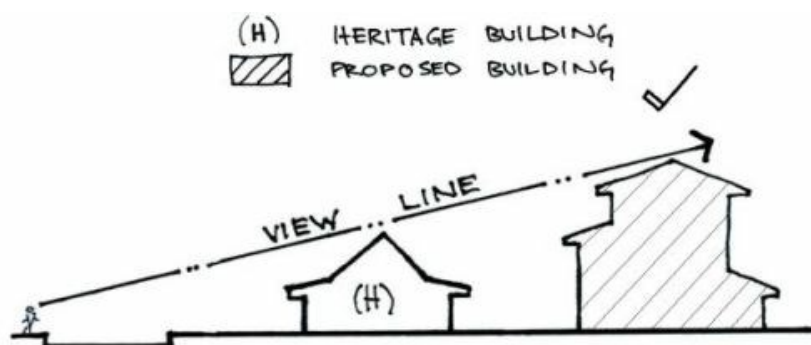
**Figure SC6.3.3.1 Illustrates desirable outcome. ‘A’ denotes key building lines and ‘B’ is the referenced roof pitch. This may provide clear representations of relationship between the heritage place and the proposed works such as floor heights, dominant fascia lines, roof lines, roof pitch etc.**

- (c) provide accurate representations of the primary design considerations: setbacks, form, massing, height, materials, finishes, and key detail elements that contribute to the significance of the heritage place;
- (d) for new buildings adjoining a heritage place, indicate key building lines in relation to the heritage place (as shown in Figure SC6.3.3.2); and



**Figure SC6.3.3.2 Key building lines in relation to the heritage place**

- (e) for new works that are proposed to be visually obscured by a heritage feature, consider demonstrating view lines using a cross section drawing (as shown in Figure SC6.3.3.3).



**Figure SC6.3.3.3 View lines using a cross-section drawing**

- (3) In addition to the requirements above, for buildings with a height greater than 2 storeys, the applicant may be requested to submit:
- (a) three dimensional perspective images inclusive of the adjacent neighbouring buildings; and
  - (b) in urban contexts in which the streetscape is of uniform height consistent with the height of the heritage place, provide an elevation drawing of the full width of the street block and nominate a "reference height".

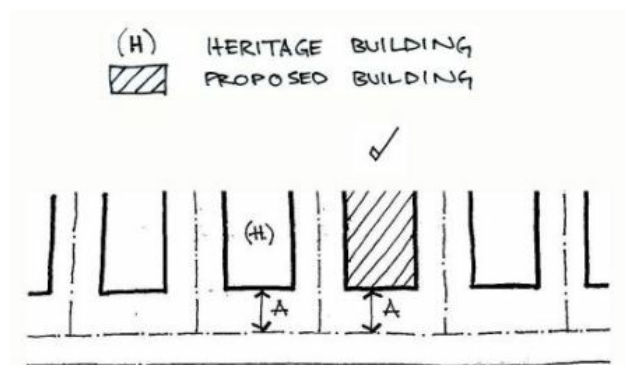
### SC6.3.4 Development adjoining a heritage place

This section of the policy provides guidance in achieving performance outcome PO13 of the [Cultural heritage overlay code](#) associated with setbacks for development, building height and scale and form of development adjoining a heritage place.

#### SC6.3.4.1 Setback for development

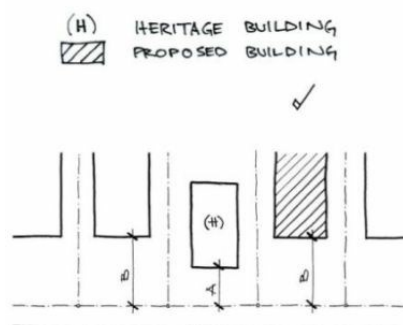
PO13 of the Cultural heritage overlay code requires that new buildings be consistent with the significant features and values of the heritage place, including, but not limited to, built form and setbacks, maintain significant views to and from the heritage place and ensure that new buildings are visually subservient.

- (1) To achieve the requirements of the performance outcomes in the code and allow for significant views to and from a heritage place to be maintained, the following design guidance should be considered.
- (a) in instances where the significance of the heritage place includes its setback in common with the established street pattern, the setback of new works ought to maintain this significance (as shown in Figure SC6.3.4.1);



**Figure SC6.3.4.1 Illustrates appropriate front setbacks for development adjoining a heritage place. "A" is the street setback distance.**

- (b) in instances where the significance of the heritage place includes its difference in setback to the established street pattern, the setback of new works ought to maintain this significance (as shown in Figures SC6.3.4.2- SC6.3.4.6); and



**Figure SC6.3.4.2 Illustrates appropriate front setbacks for development adjoining a heritage place. "A" and "B" is the street setback distance.**

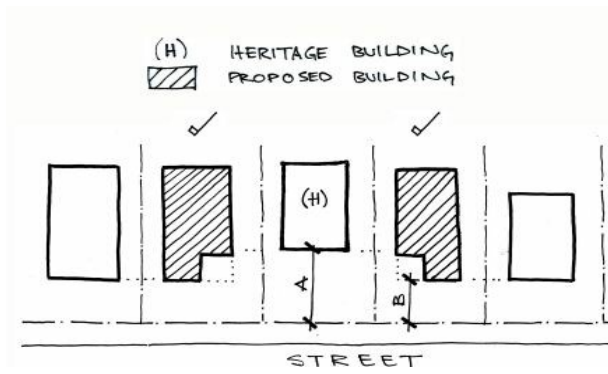


Figure SC6.3.4.3 Illustrates appropriate front setbacks for development adjoining a heritage place. "A" and "B" is the street setback distance

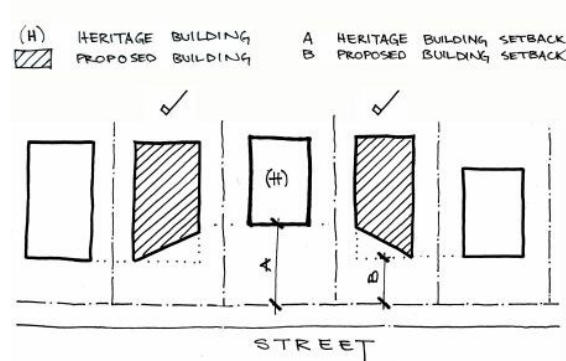


Figure SC6.3.4.4 Illustrates appropriate front setbacks for development adjoining a heritage place. 'A' and 'B' is the street setback distance

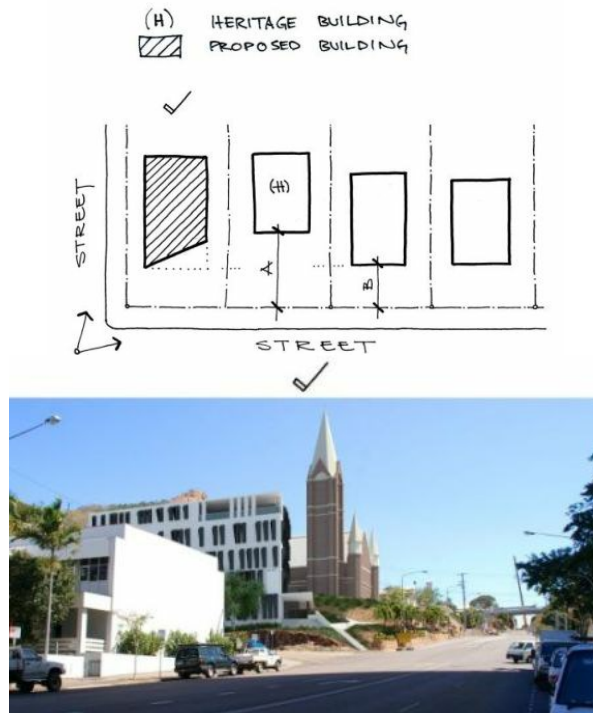
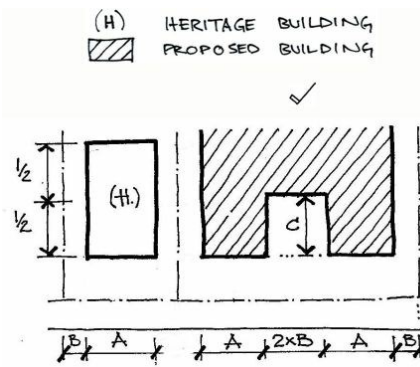


Figure SC6.3.4.5 Illustrates appropriate corner block front setback for development adjoining a heritage place. "A" and "B" is the street setback distance. The setback of new development is tapered to allow improved views to the heritage place.

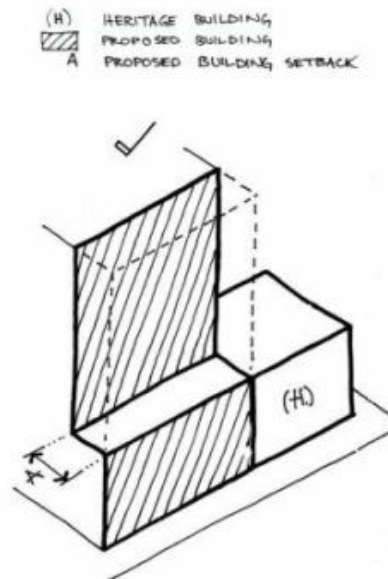
- (c) in order to achieve visual subservience to a heritage place in accordance with PO13, building form ought to be articulated into smaller elements to relate to scale, rhythm and spacing of the heritage place and its context (as shown in Figure SC6.3.4.6).



**Figure SC6.3.4.6 Illustrates sympathetic building frontage rhythm. "B" is side setback; "C" (being the depth separation to get sympathetic building frontage rhythm) is 6m or  $\frac{1}{2}$  of "H" (heritage building depth)**

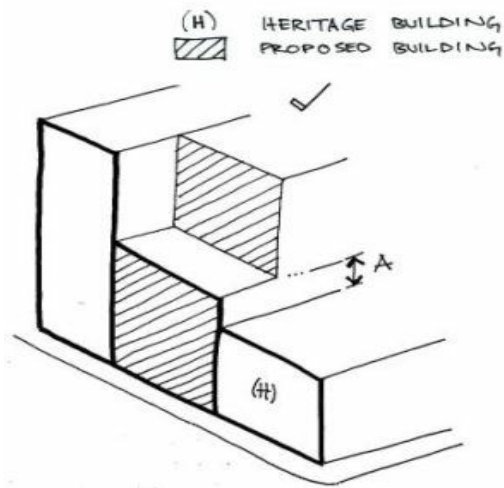
#### SC6.3.4.2 Building height

- (1) Where parts of the development are proposed to be taller than adjacent significant heritage elements, the following design guidance may be considered to demonstrate achievement of performance outcome PO13 of the [Cultural heritage overlay code](#):
  - (a) proposed taller elements of the proposed new building are to be setback to diminish their impact (as shown in Figure SC6.3.4.7);



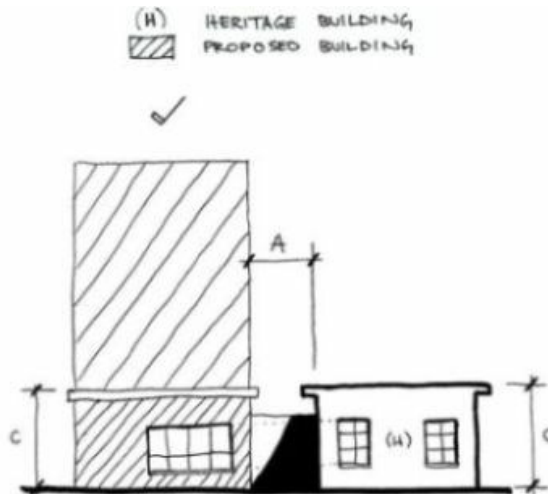
**Figure SC6.3.4.7 Illustration of building setback of taller new building. "A" is equal or greater than 3m**

- (b) setback upper levels of the proposed new building to provide a transition between adjacent buildings of different scales (as shown in Figure SC6.3.4.8);



**Figure SC6.3.4.8 Illustration of new building upper level setbacks. Dimension "A" is within 20% of the adjacent heritage building height**

- (c) provide an appropriate separation gap between the significant heritage elements and taller new elements (as shown in Figure SC6.3.4.9);
- (d) building elements in the separation gap may be recessed and of lower height and/or different material than the heritage building, (as shown in Figure SC6.3.4.9); and

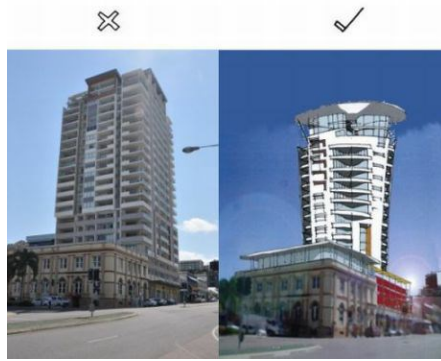


**Figure SC6.3.4.9 Illustration of separation gap between contributing heritage elements and taller new buildings. "A" is Separation and "C" is the Common Reference Height**



**Figure SC6.3.4.10 An example of a desirable outcome – free standing tower provides a significant landscaped public piazza which acts as a separation adjacent to the heritage place**

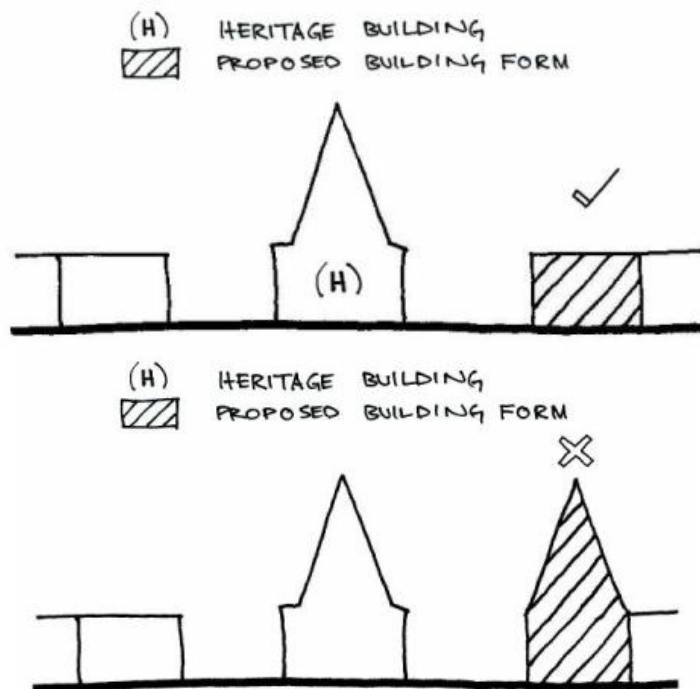
- (e) new building works reflect a 'reference height' for the full width of the street frontage where the 'reference height' is consistent with the height of the adjacent heritage building (as shown in Figure SC6.3.4.11).



**Figure SC6.3.4.11 An example of an undesirable outcome (left): tower element with no setbacks to the street boundary or adjacent heritage building which is detrimental to the otherwise uniform streetscape heights and the adjacent heritage building. An example of a desirable outcome (right): tower element setback from the street boundary and the adjacent heritage building to reduce the impact of its height and bulk. Podium element references the heights of the adjacent heritage building and streetscape.**

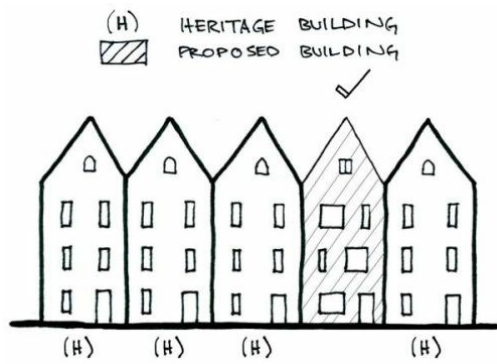
**SC6.3.4.3 Scale and form of development adjoining a heritage place**

- (1) The following design examples are associated with building scale and form and may be considered to demonstrate achievement of performance outcome PO13 of the [Cultural heritage overlay code](#).
  - (a) in instances where the significance of the heritage place form includes its difference in scale to its setting, the scale of new works is to maintain this significance (as shown in Figure SC6.3.4.12); or



**Figure SC6.3.4.12 Illustration of desirable and undesirable outcome**

- (b) in instances where the significance of the heritage place form includes its common scale and form to its setting, the scale and form of new works is to maintain this significance (as shown in Figure SC6.3.4.13); and

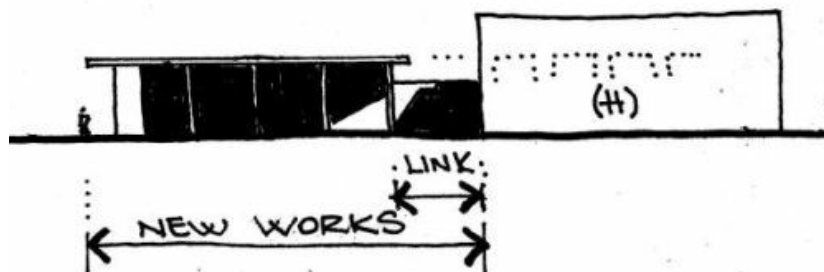


**Figure SC6.3.4.13 Illustration of development maintaining common scale**

- (c) new building works should generally not directly copy the heritage place and as an example, should be readily distinguishable from it. Use of similar overall form, scale, proportions and materials is appropriate (as shown in Figure SC6.3.4.14 and SC6.3.4.15);

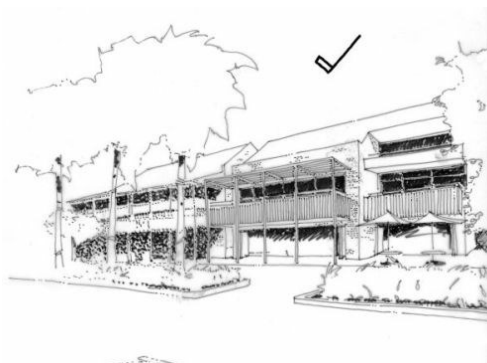


**Figure SC6.3.4.14 Illustrates an example of appropriate scale and form**



**Figure SC6.3.4.15 Illustrates desirable outcome – pavilion type addition**

- (d) new building works should not reference non-significant features and atypical elements (as shown in Figure SC6.3.4.16 to SC6.3.4.17); and



**Figure SC6.3.4.16 Illustrates desirable outcome**





**Figure SC6.3.4.17 Illustrates undesirable outcome - new building adjacent to a heritage place does not recognise characteristic articulation of materials, textures and colours (Palmer Street, Townsville)**



**Figure SC6.3.4.18 An example of an undesirable outcome: design of the new building referenced non-contributory features of the former streetscape, such as angled light poles that have subsequently been removed (Flinders Street East, Townsville)**

- (e) the quality of new materials is commensurate with those of the heritage place.

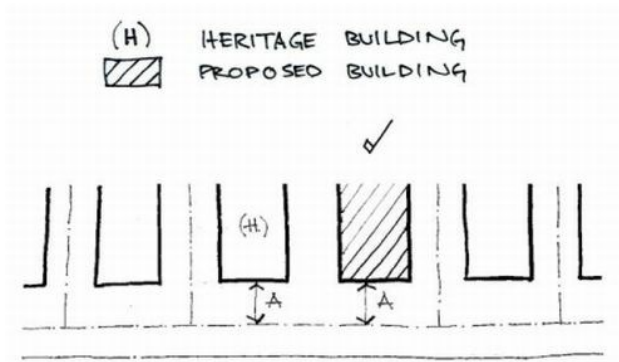
### **SC6.3.5 Development within a heritage place**

This section of the policy provides guidance in achieving performance outcomes PO1, PO3 – PO6, PO8 – PO10 of the [Cultural heritage overlay code](#) associated with setbacks for development, building height, the scale and form of development, the heritage setting, landscaping and open space, building elements and advertising devices associated with development within a heritage place.

#### **SC6.3.5.1 Setbacks for development**

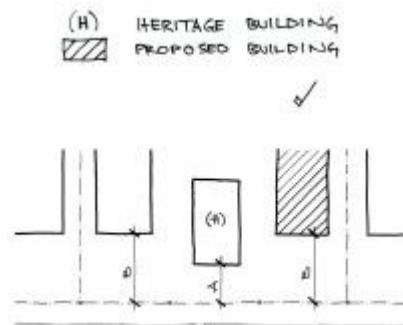
PO3 and PO4 of the Cultural heritage overlay code require that new buildings to be consistent with the significant features and values of the heritage place, including, but not limited to, built form and setbacks, maintain significant views to and from the heritage place and ensure that new buildings are visually subservient.

- (1) To achieve the requirements of the performance outcomes in the code and allow for significant views to and from a heritage place to be maintained, the following design guidance should be considered.
  - (a) in instances where the significance of the heritage place includes its setback in common with the established street pattern, the setback of new works ought to maintain this significance (as shown in Figure SC6.3.5.1);

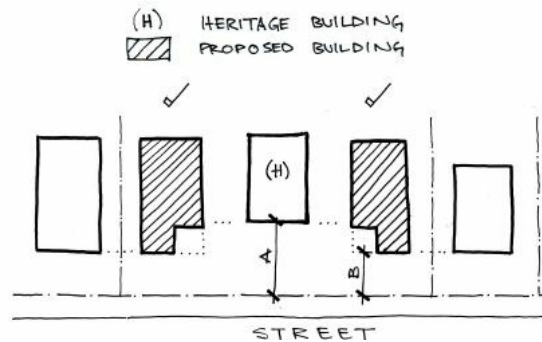


**Figure SC6.3.5.1 Illustrates appropriate front setbacks for development within a heritage place, "A" is the street setback distance**

- (b) in instances where the significance of the heritage place includes its difference in setback to the established street pattern, the setback of new works ought to maintain this significance (as shown in Figures SC6.3.5.2 to SC6.3.5.3); and



**Figure SC6.3.5.2 Illustrates appropriate front setbacks for development within a heritage place, "A" and "B" is the street setback distance**



**Figure SC6.3.5.3 Illustrates of appropriate front setbacks for development within a heritage place, "A" and "B" is the street setback distance**

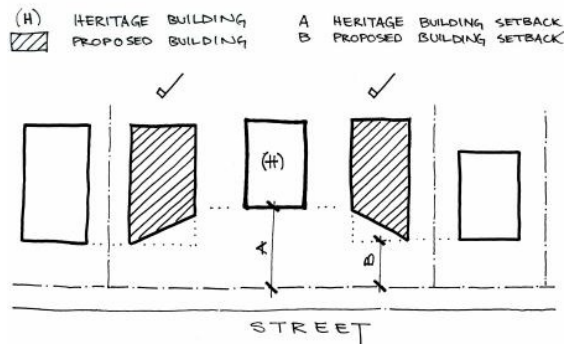


Figure SC6.3.5.4 Illustrates appropriate front setbacks for development within a heritage place and development adjoining a heritage place. "A" and "B" is the street setback distance

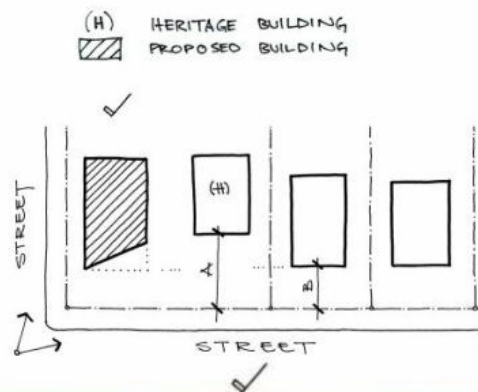


Figure SC6.3.5.5 Illustrates appropriate corner block front setback for development on a heritage place. "A" and "B" is the street setback distance. The setback of new development is tapered to allow improved views to the heritage place.

- (c) new developments should adopt side setbacks that are common with the heritage place, unless this would diminish a significant feature of the heritage place (as shown in Figure SC6.3.5.6).

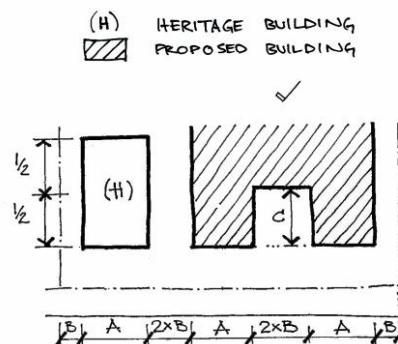
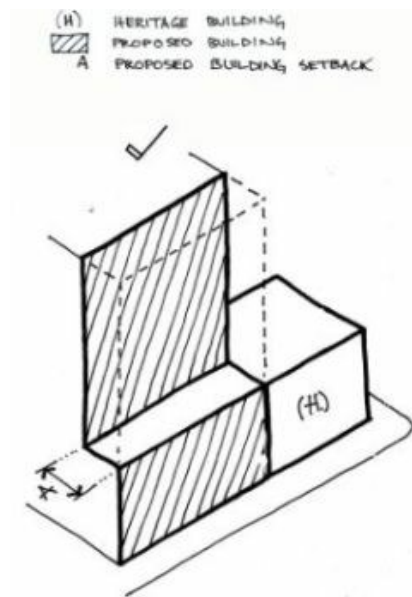


Figure SC6.3.5.6 Illustrates sympathetic building frontage rhythm, "B" is side setback and "C" (being the depth separation to get sympathetic building frontage rhythm) is 6m or  $\frac{1}{2}$  of "H" (heritage building depth).

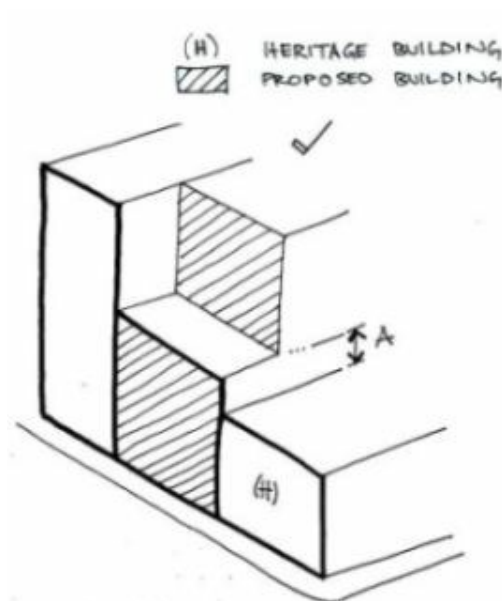
### SC6.3.5.2 Building height

- (1) Where parts of the development are proposed to be taller than adjacent heritage elements, the following design guidance may be considered to demonstrate achievement of performance outcome PO3, PO4 and PO5 of the [Cultural heritage overlay code](#).
- (a) proposed taller elements of the proposed new building are to be setback to diminish their impact (as shown in Figure SC6.3.5.7); or



**Figure SC6.3.5.7 Illustrates building setback of taller new building. "A" is equal or greater than 3m**

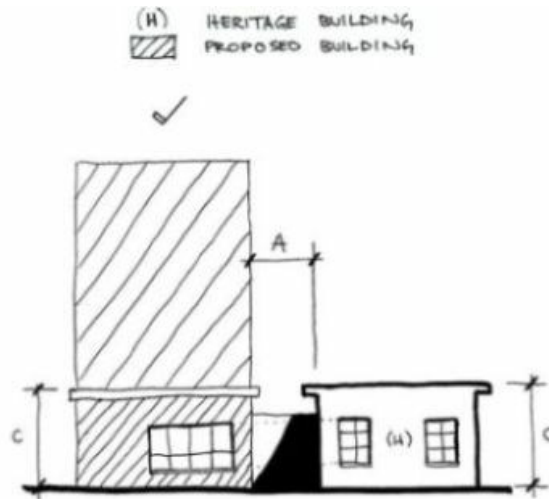
- (b) setback upper levels of the new building to provide a transition between adjacent buildings of different scales (as shown in Figure SC6.3.5.8);



**Figure SC6.3.5.8 Illustrates new building upper level setbacks. Dimension "A" is within 20% of the adjacent heritage building height**

- (c) provide an appropriate separation gap between the significant heritage elements and taller new elements (as shown in Figure SC6.3.5.9);
- (d) building elements in the separation gap may be recessed and of lower height and/or different material than the heritage building (as shown in Figure SC6.3.5.9); and

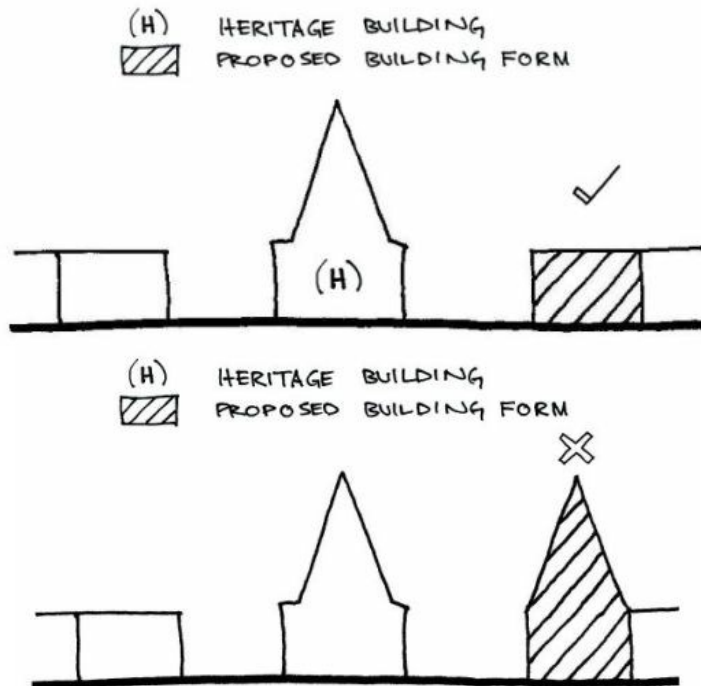
- (e) new building works may reflect a "reference height" for the full width of the street frontage where the "reference height" is consistent with the height of the adjacent heritage building (as shown in Figure SC6.3.5.9).



**Figure SC6.3.5.9 Illustrates separation gap between contributing heritage elements and taller new buildings. "A" is the separation gap. "C" is the common reference height.**

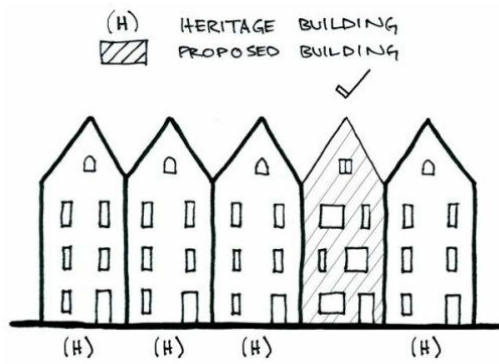
**SC6.3.5.3 Scale and form development**

- (1) The following design examples are associated with building scale and form and may be considered to demonstrate achievement of performance outcome PO3 – PO6 of the Cultural heritage overlay code.
  - (a) in instances where the significance of the heritage place form includes its difference in scale to its setting; the scale of new works is to maintain this significance (as shown in Figure SC6.3.5.10); or



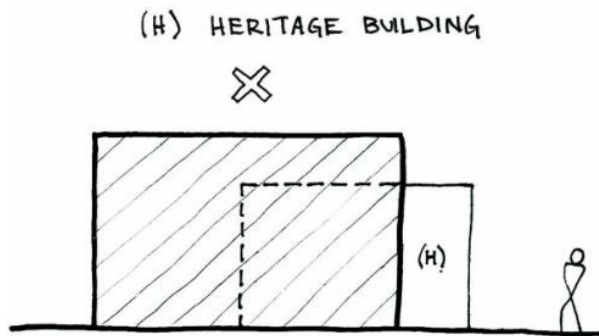
**Figure SC6.3.5.10 Illustrates desirable and undesirable outcome**

- (b) in instances where the significance of the heritage place form includes its common scale, proportions and form to its setting, the scale, proportions and form of new works is to maintain this significance (as shown in Figure SC6.3.5.11);

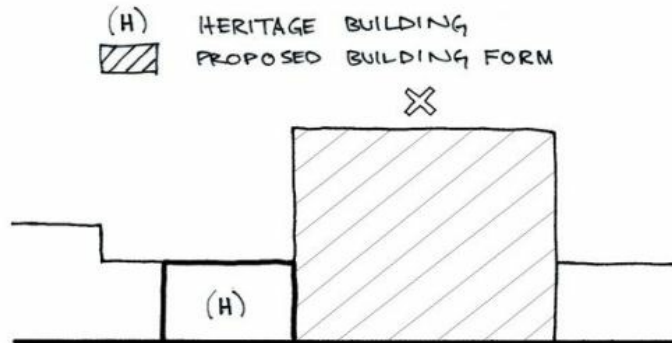


**Figure SC6.3.5.11 Illustrates an example of appropriate scale and form**

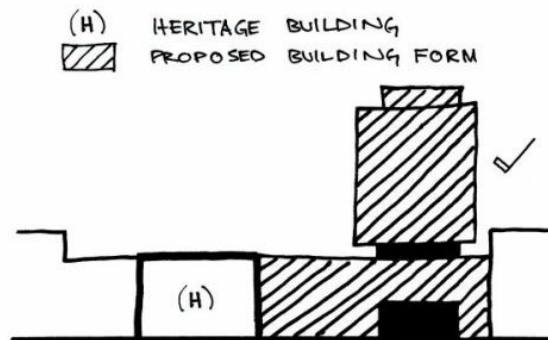
- (c) the scale of new works should be compatible with, and not diminish the setting of the heritage place (as shown in Figures SC6.3.5.12 – SC6.3.5.14);



**Figure SC6.3.5.12 Illustrates an example of an undesirable outcome – new works obscures the heritage place**

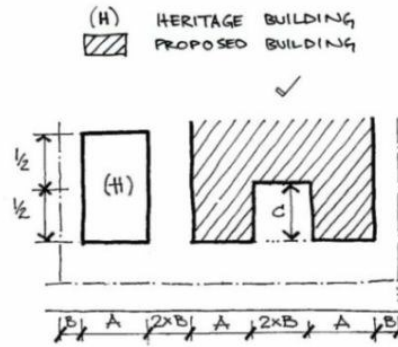


**Figure SC6.3.5.13 Illustrates an example of an undesirable outcome: scale of new works dominates the heritage place and is detrimental to the settings of the heritage place**



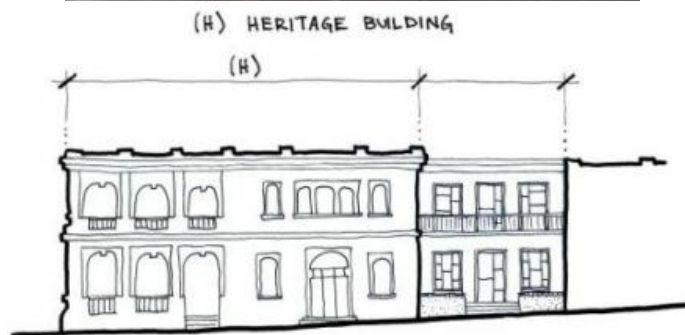
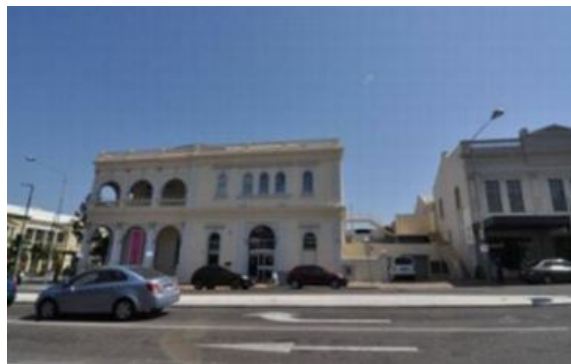
**Figure SC6.3.5.14 Illustrates an example of a desirable outcome with regard to scale and form**

- (d) in order to achieve visual subservience to a heritage place in accordance with PO4, building form ought to be articulated into smaller elements to relate to scale, rhythm and spacing of the heritage place and its context (as shown in Figure SC6.3.5.15);



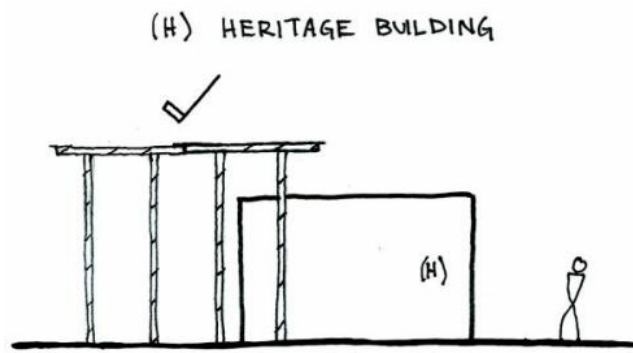
**Figure SC6.3.5.15 Illustrates sympathetic building frontage rhythm, "B" is side setback and "C" (being the depth separation to get sympathetic building frontage rhythm) is 6 m or  $\frac{1}{2}$  of "H" (heritage building depth).**

- (e) new buildings should respond to existing ridge or parapet lines, roof slopes or other significant features of the heritage place (as shown in Figure SC6.3.5.16);



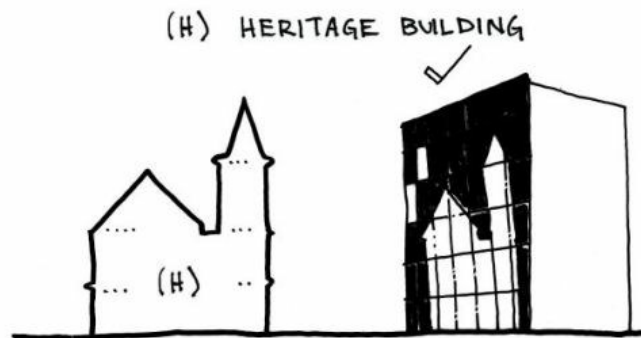
**Figure SC6.3.5.16 Illustrates an example of an appropriate outcome. The proposed new development adopts ridge and parapet lines of the heritage place and enhances the continuity of the streetscape**

- (f) new building works should not reference non-significant features and atypical elements;
- (g) new works should provide elements of design that are clearly distinguishable from heritage elements and that assist in representing the historical form of the heritage place (as shown in Figure SC6.3.5.17); and

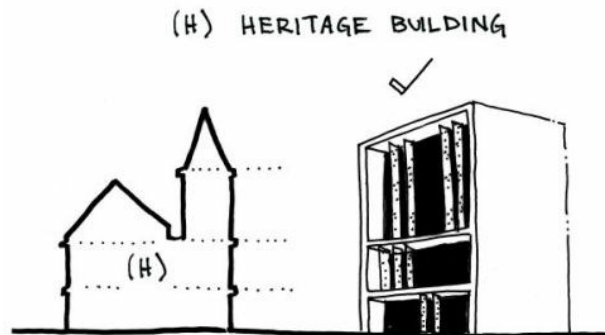


**Figure SC6.3.5.17 Illustrates an example of an appropriate outcome, where new works are detached and expressed as a lightweight addition**

- (h) architectural expression of new works should avoid diminishing the setting of the heritage place (as shown in Figure SC6.3.5.18 and Figure SC6.3.5.19).



**Figure SC6.3.5.18 Illustrates an example of a desirable outcome, in which a glazed or glass façade reflects the heritage place**



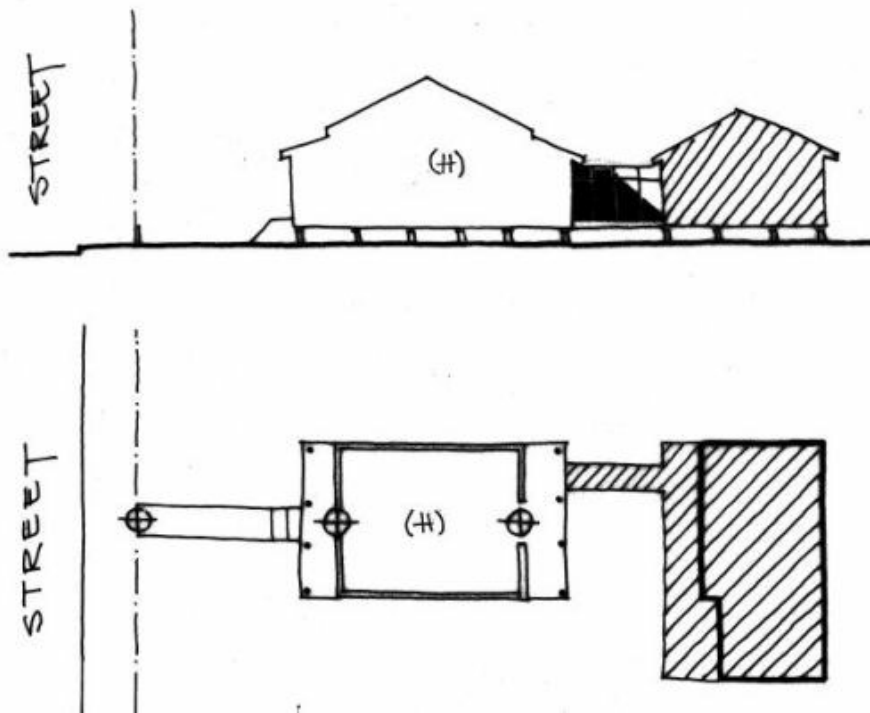
**Figure SC6.3.5.19 Illustrates an example of an undesirable outcome, in which the contemporary expression of new works reference the heights of the heritage place**

#### SC6.3.5.4 The heritage setting

The following is advice for achieving PO3, PO4 and PO5 of the [Cultural heritage overlay code](#) associated with the heritage setting.

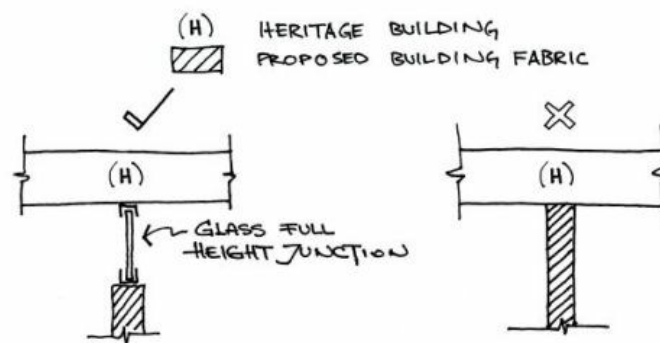
- (1) New buildings or works minimise visual impacts to the heritage place by:
  - (a) new buildings are set apart in a separate building (as shown in Figure SC6.3.5.20);



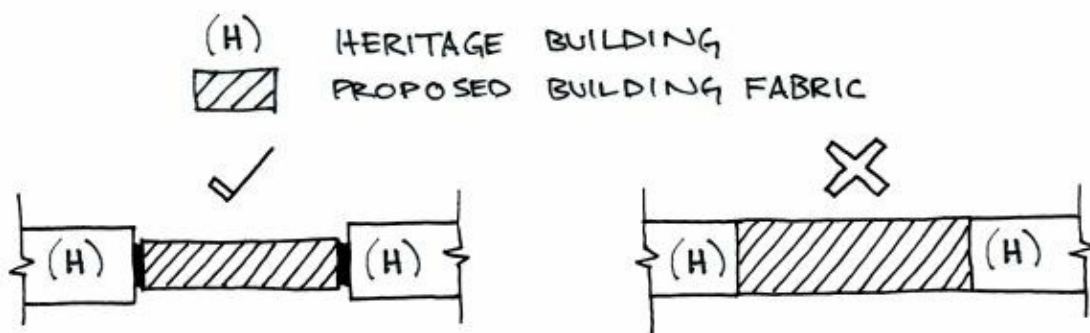


**Figure SC6.3.5.20 Illustrates an example of a desirable outcome**

- (b) new works should design junctions between new and old fabric to be legible, reversible and may be incorporated into the overall architectural design (as shown in Figure SC6.3.5.21 and Figure SC6.3.5.22); and

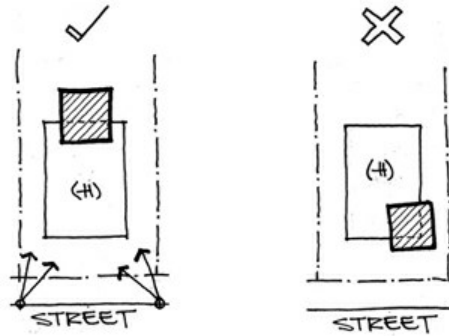


**Figure SC6.3.5.21 Illustrates desirable and undesirable outcome: plan detail of old and new wall junction separation of new and old fabric using glass or other translucent light weight material**

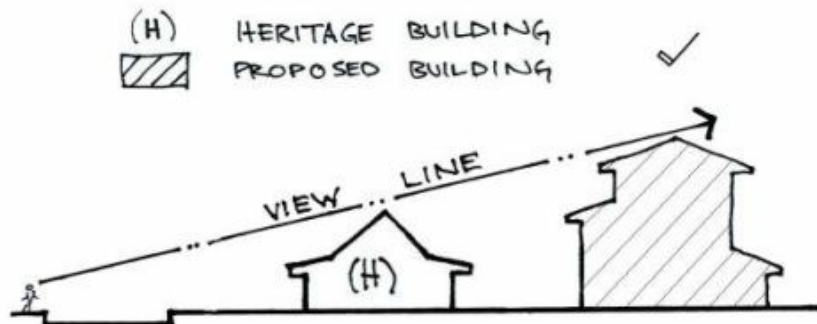


**Figure SC6.3.5.22 Illustrates desirable and undesirable outcome - plan detail of the junction between the proposed/new development to the existing heritage wall opening. The new development requires a reduced wall depth to maintain the legibility of the original opening**

- (c) works are located within areas that are not visible from the dominant street views or other significant views, and do not diminish any significant features of the heritage place (as shown in Figure SC6.3.5.23 and SC6.3.5.24).



**Figure SC6.3.5.23 Illustrates an example of desirable and undesirable outcome**

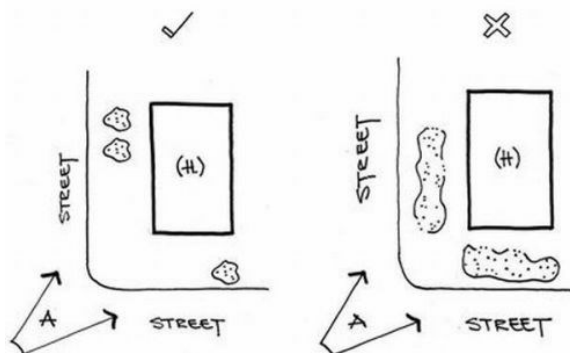


**Figure SC6.3.5.24 Illustrates view line from the street. The new building at the back cannot be seen by a person standing across the street, which means that the view of the heritage building is not diminished**

**SC6.3.5.5 Landscaping and open space**

The following advice is for demonstrating achievement of performance outcome P03 and PO8 of the [Cultural heritage overlay code](#) associated with landscaping and open space.

- (1) Open space and landscaping features should maintain views to and from the significant heritage features of the heritage place (as shown in Figure SC6.3.5.25– SC6.3.5.28).



**Figure SC6.3.5.25 Illustrates an example of desirable and undesirable outcome. "A" is principal view to and from heritage place**

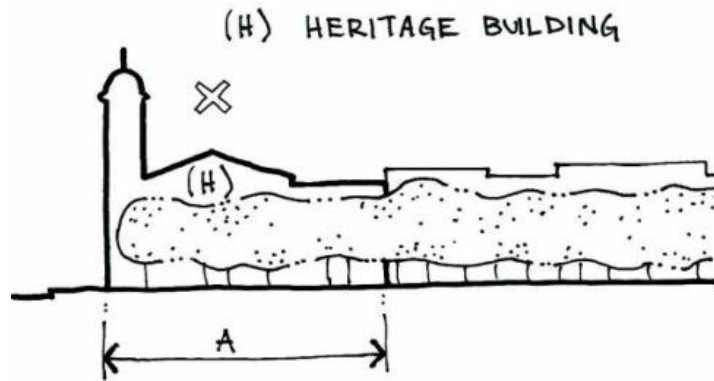
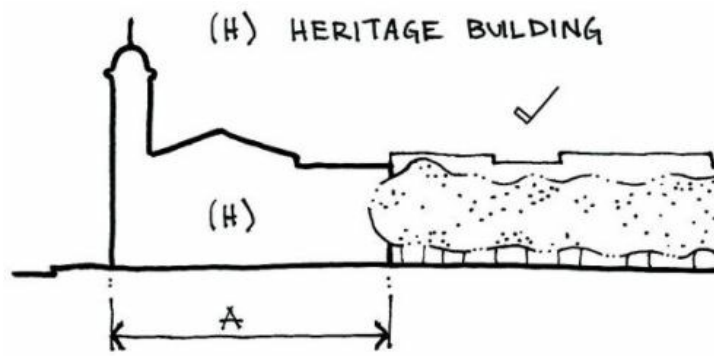


Figure SC6.3.5.26 Illustrates an example of desirable outcome "A" is street width

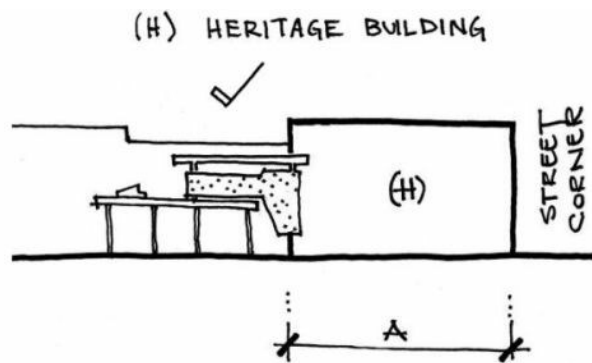


Figure SC6.3.5.27 Illustrates an example of a desirable outcome, tall street shelter element does not block views to and from the heritage place. "A" is street width of "H"

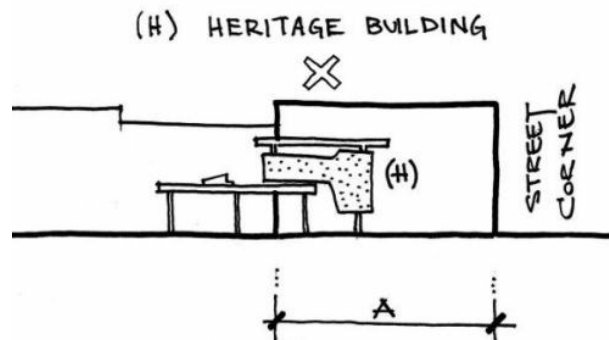
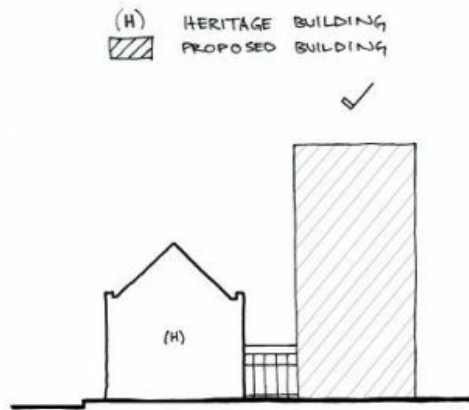


Figure SC6.3.5.28 Illustrates an example of an undesirable outcome, where a tall street shelter element blocks views to and from the heritage place. A' is street width of "H" (heritage place)

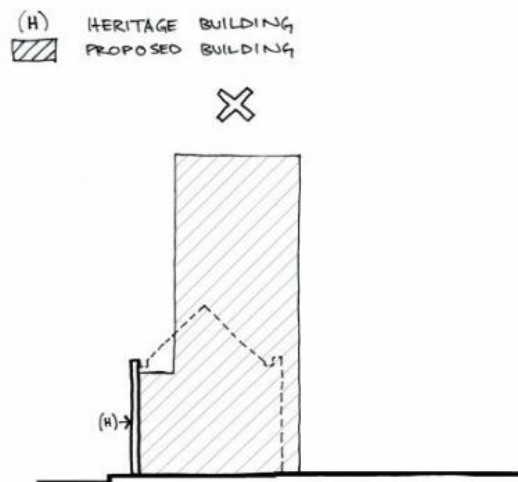
### SC6.3.5.6 Heritage fabric

In order to protect the cultural significance of a heritage place, retaining the original fabric and significant fenestration patterns, finishes and decorative details should be a primary aim.

- (1) The following should be considered in demonstrating achievement of performance outcomes PO1 and PO6 of the [Cultural heritage overlay code](#).
  - (a) alteration or partial demolition of elements that do not contribute to cultural significance may be appropriate where there is no detrimental impact on significant features;
  - (b) buildings are to be retained in their three dimensional form. The inadequate retention of only the front façade may result in "facadism" and should be avoided (as shown in Figure SC6.3.5.29 and SC6.3.5.30);



**Figure SC6.3.5.29 Illustrates an example of a desirable outcome, new works with adequate retention of the three dimensional form. New works set back as a detached form.**



**Figure SC6.3.5.30 An example of an undesirable outcome; new works have inadequate retention of the three dimensional form (only the front façade has been retained)**

- (c) the building fabric that contributes to the significance of the heritage place should be retained whether visible or not from the public realm (as shown in Figure SC6.3.5.31);



**Figure SC6.3.5.31 “The Brewery”, former Post Office (Flinders Street, Townsville). Significant features of the interior have been retained. This is an example of maintaining original building fabric.**

- (d) significant associations and meanings of the heritage place ought to be maintained (as shown in Figures SC6.3.5.32 and SC6.3.5.33); or
- (e) new works provide interpretations for, associations and meanings of the heritage place, and its original use;
- (f) where a new use is proposed for a heritage place, the new use is compatible with the cultural significance, significant features and values of the heritage place (as shown in Figures SC6.3.5.32 and SC6.3.5.33);

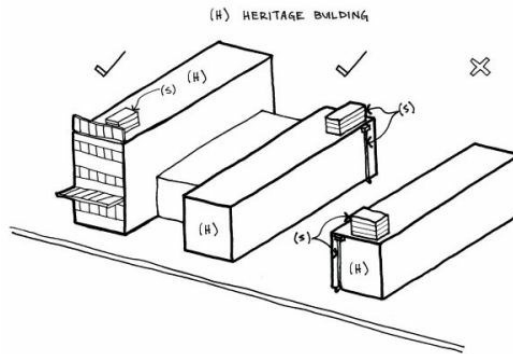


**Figure SC6.3.5.32 Illustrates a desirable outcome: former Post Office building (Flinders Street, Townsville)**



**Figure SC6.3.5.33 Illustrates an undesirable outcome: former Customs House (The Strand, Townsville). Change of use to a private residence diminishes the associations and meanings of the heritage place**

- (g) building services may be concealed to render them not readily visible from the street or any significant views of the heritage place. If services are by necessity visible, they may be constructed using materials and details sympathetic to those of the heritage place (as shown in Figure SC6.3.5.34); and



**Figure SC6.3.5.34 Examples of desirable and undesirable outcome, "S" are air conditioning and drainage locations. An example of an undesirable outcome is at right, with air conditioning and drainage services positioned to the front of the building, which has a detrimental impact on visual amenity of the heritage place**

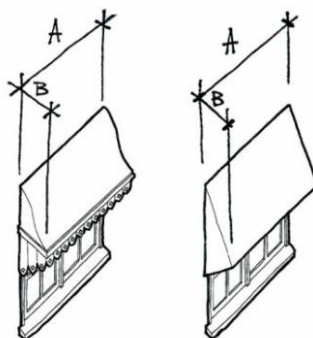
- (h) any changes to significant fabric necessary to accommodate a new use are reversible.

#### SC6.3.5.7 Building elements

This section will assist you to demonstrate achievement with PO3, PO5 and PO6 of the [Cultural heritage overlay code](#).

Building elements refer to the components of a building which contribute to the overall character and heritage significance of the building, site or area, and may include the materials, colours and details used.

- (1) Materials, colours and details used in a development should complement rather than reproduce the heritage place. The following design guidance illustrates how this might be achieved:
- (a) the design of new works recognises characteristic materials, textures and colours used locally and in adjacent buildings. These may be re-interpreted and incorporated in the design of the new building (as shown in Figure SC6.3.5.35);



**Figure SC6.3.5.35 Illustrates (left) contemporary interpretation of a typical heritage awning hood (right) where dimensions "A" and "B" have similar proportions.**

- (b) materials and colours of surrounding buildings generally should not be copied but used as a point of reference. Modern materials may be used if their proportions and details are sympathetic within the adjacent heritage place;
- (c) colour, texture and tonal contrast of new building elements may be utilised as a unifying element with heritage features. Details that contribute to the significance of the heritage place may inform or inspire the design of new building works;
- (d) modern details may be designed to reinterpret traditional details and create new relationships between new and old; and

- (e) the quality of new materials is of the same quality as those of the heritage place.
- (2) New materials introduced to a heritage place should generally be intentionally varied from the original and be distinguishable from the original fabric by a date stamp (as shown in Figure SC6.3.5.36).



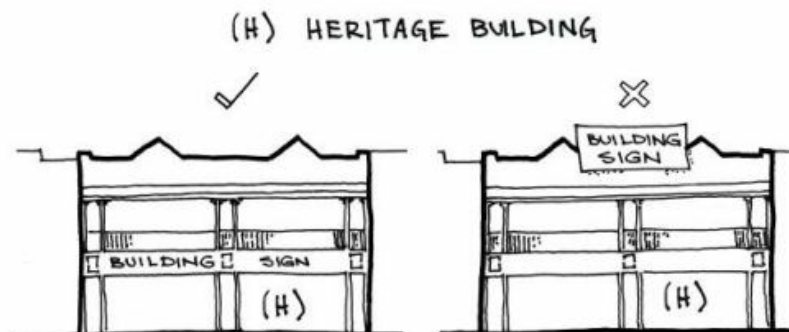
**Figure SC6.3.5.36 Illustrates an example of a desirable outcome - date stamp on new or introduced fencing panel**

### SC6.3.5.8 Advertising devices

- (1) Advertising devices should be designed to ensure that they do not dominate the heritage place or obscure significant views or features of the heritage place. The following is advice for achieving performance outcome PO8, PO9 and PO10 of the [Cultural heritage overlay code](#) associated with advertising devices.

**Note**— there are specific requirements when dealing with State Heritage listed buildings. Advertising devices on heritage buildings listed on the [Queensland State Heritage Register](#) is subject to the provisions of the [Queensland Heritage Act 1992](#).

- (a) advertising devices should be readily removable without damaging the building fabric, (as shown in Figure SC6.3.5.37);



**Figure SC6.3.5.37 Illustrates a desirable outcome (left) and undesirable outcome (right)**

- (b) advertising devices may be clearly modern yet respectful of the heritage context, associations and meanings of the heritage place;
- (c) advertising devices should consider enhancing a building's architecture and setting;
- (d) integrate advertising devices with architectural features of the building wherever possible;
- (e) unless there is adequate evidence – physical and documentary – to reconstruct original advertising devices, new advertising devices on a heritage place should complement, not replicate, a "period" style. "Old fashioned" imitation signage would be inappropriate. Any form of signage may be considered, as long as visual and physical impacts on the heritage building are minimised;
- (f) the appropriate size of signage may be relative to the specific architectural characteristics of the heritage place (as shown in Figure SC6.3.5.38); and
- (g) table SC6.3.5.1 identifies advertising devices which are not suitable on a heritage building.

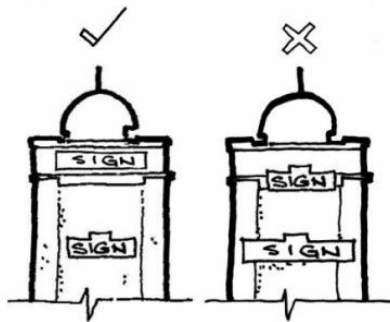



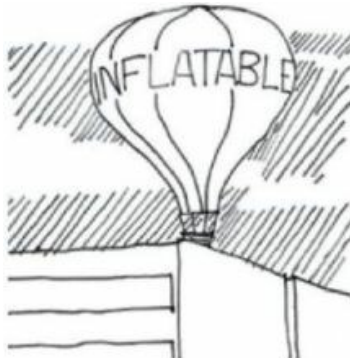


Figure SC6.3.5.38 Illustrates a desirable outcome (left) and undesirable outcome (right)


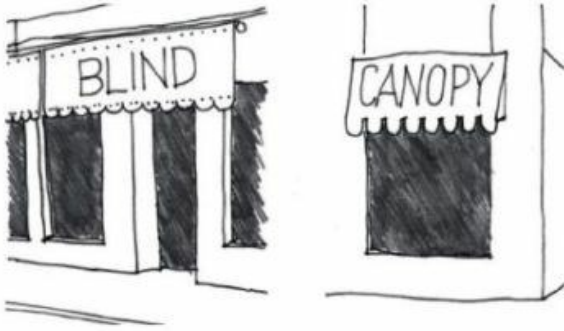


Table SC6.3.5.1 Advertising devices which are not suitable on a heritage building



Device type	An example of an undesirable outcome
Roof signs	
Above awning signs	
Wall sign	
Inflatable sign	



In accordance with AO3 of the [Advertising devices code](#), Table SC6.3.5.2 identifies the desirable outcomes for heritage places on Flinders Street East. Advertising devices are in accordance with the advertising device types and design parameters set out within Table SC6.3.5.2.

**Table SC6.3.5.2 Design parameters for supported advertising devices on Flinders Street East**

Device type	Design Parameters additional to those set out in the advertising devices code	An example of an desirable outcome
<b>Awning fascia sign</b>		
<b>Blind/canopy</b>		
<b>Under awning sign</b>		
<b>Under Awning sign</b> (where an under-awning sign is affixed between posts of a footpath awning)	The under-awning sign must be contained within the spacing of posts and must not exceed 600mm in height.	

<p><b>Wall sign</b></p>		
<p><b>Window sign</b></p>		

### SC6.3.6 Preparing a heritage impact statement report

A heritage impact statement may be required to demonstrate compliance with the [Cultural heritage overlay code](#), in particular performance outcomes PO1, PO3, PO4, and PO7.

A heritage impact statement provides specific information about how a proposed development will affect the heritage place. The purpose of a heritage impact statement is to identify any potential detrimental impacts that the development may have on the significance of the place. Ultimately, a heritage impact statement should demonstrate compliance with the Cultural heritage overlay code.

A heritage impact statement is to be produced by a suitably qualified architect or cultural heritage professional, and should include the following at a minimum:

- (1) Description of the proposed development  
Provide a brief description of the proposed development including:
  - (a) type of development;
  - (b) range and scope of work proposed; and
  - (c) timeframe for carrying out work.
  
- (2) Setting and context of the place  
Describe the setting or context for the place, including photographs and maps showing significant features that will be affected. Provide an analysis of the affect the proposed development will have on the setting of the heritage place.
  
- (3) Proposed changes to the heritage place  
List the changes required to the heritage place as a consequence of the proposed development and provide the following information about each change:
  - (a) what elements or aspects of the heritage place are affected by the proposed change;
  - (b) list the work required to effect the proposed change;
  - (c) analysis of the impact of the change on the cultural heritage significance of the place;
  - (d) assessment of potential for detrimental impact on the cultural heritage significance;

- (e) if the proposed work will directly affect a heritage element of the place – provide details of proposed work methods; and
  - (f) where the proposed change is assessed as having potential for detrimental impact, provide information about the following:
    - (i) why the proposed change is required;
    - (ii) alternative solutions that were investigated; and
    - (iii) what measures are included in the proposed development to reduce detrimental impact that may result from the change.
- (4) Applicable conservation policies
- (a) some heritage places already have conservation management plans that include conservation policies. Where a heritage building has a current conservation management plan, the heritage impact statement will need to list the conservation policies that relate to the proposed development and describe how they have guided the development;
  - (b) where conservation policies have not been followed, give reasons why the conservation policies were not used and describe the process that is proposed to be followed; and
  - (c) where conservation policies are not already available, an architect or heritage consultant can provide conservation advice to help inform the planning and guide development of places.
- (5) References
- List documents referred to in the heritage impact statement such as conservation policies, conservation management plans, condition report (i.e. demolition reports), and specialist consultants' reports.

*(Adapted from 'Guideline: Preparing a heritage impact statement' Department of Environment and Heritage Protection, 2011).*

### **SC6.3.7 Preparing a condition report**

If an application is proposing the demolition of a structure of heritage significance the applicant may be requested to provide a condition report. The condition report should, at a minimum, include consideration of:

- (1) the structural stability of the building in the form of a structural engineers report. The condition report must include a factual statement from an appropriately qualified structural engineer about the condition of the building; and
- (2) a pest inspection report and other supporting documentation may also be provided.

### **SC6.3.8 Preparing archival recording of heritage place**

Archival recording may be required to demonstrate achievement of performance outcome PO2 of the [Cultural heritage overlay code](#). Where demolition, change or relocation of a heritage building is allowed, a photographic record and measured drawings in accordance with the following of the place should be submitted to council prior to the commencement of the demolition works or relocation of the heritage building.

#### **SC6.3.8.1 Guideline for photographic recording**

The following guidelines are intended as a checklist for making an accurate photographic record of sites, buildings, objects, gardens or structures of heritage significance prior to major alterations or demolition. The recording process must be comprehensive and cover the parts specified in the approval conditions.

- (1) Aim
 

The aim of the photographic record is to provide a sufficient number of photographs to fully illustrate the subject for which the photographic archival record is required. The purpose of the record is to provide permanent documentation of places so that future generations can benefit from and gain an understanding of Townsville's cultural history that is no longer possible to pass on to them.
- (2) Method
 

The photographer should be informed by any available plans and documentary evidence and should have an

understanding of the history and operations of the place. If necessary the photographer should be accompanied on the site by a person familiar with the site's heritage significance and the processes related to it. The project should be planned before commencement and the photographer aware of the appropriate sequence.

The preferred shooting method is to proceed from the overall or general through to the detailed or specific. The photographic record should consist of:

- (a) general views of the place.  
**Note**—to provide its context and overall coverage of all slides – oblique shots are useful for general reference;
- (b) elevation of all sides;
- (c) details of all key elements including windows, doors, eaves, cornices, rainwater goods, skirtings and decorative elements;
- (d) interior elevations of each space to include floor and ceiling finishes;
- (e) the relationship of the elevations to any equipment or relics housed in each space;
- (f) any significant items should be photographed;
- (g) any features particular to the place internally and externally should be fully recorded; and
- (h) when photographing landscape elements:
  - (i) an overall photograph is required; and
  - (ii) any unusual or distinguishing features should be fully recorded.

(3) Key plans

The photographic record shall include a plan or plans indicating the direction in which the photographs were taken. The positions, with a direction arrow, should be numbered and cross referenced to the photographs.

- (a) The following information should be included:
  - (i) date of record production;
  - (ii) name of photographer; and
  - (iii) description of place (e.g. building, name, species of tree, etc.).
- (b) Form
  - (i) photographs are to be colour and of professional quality. Digital format will be accepted. An electronic copy on CD, USB or of the like format acceptable to council, are to be submitted;
  - (ii) archival quality ink should be used for annotation and cross referencing. A 6B pencil should only be used for annotating on the back of prints; and
  - (iii) the photographic record should be submitted in an A4 archival album with photographs in archival quality plastic sleeves or pockets.
- (c) Size
  - (i) minimum size of prints should be 100 x 150 mm, to a maximum A4 size.
- (d) Report
  - (i) a very brief report or introduction explaining the purpose of the report, a brief description of the subject and detailing the sequence in which the photographs were taken should be included;
  - (ii) the report may also address the limitations of the photographic record and make recommendations for future work; and
  - (iii) sources of original work should be acknowledged.

**SC6.3.8.2 Guideline for measured drawings**

Measured drawings provide an accurate record of buildings, structures or objects and depict the physical features that contribute to their heritage significance. Measured drawings should be easy to read and suitable for reproduction. Australian Standard AS 1100 *Technical Drawing*, Part 301 and *Supplement 1, Architectural Drawing* provides a guide to suitable graphics.

The following guidelines are intended as a checklist for making an accurate record of a building, part of a building, or other subject at the time of production. The recording process must be comprehensive and cover the parts specified in the approval conditions.

(1) Aim

The aim of producing a measured drawing is to provide a record that is measured and drawn accurately to scale. It should be a true reflection of the existing condition and not an interpretation of a previous state (i.e. missing elements should not be included and elements which are not plumb should be recorded as such).

(2) Drawings:

- (a) the measured drawings should be cross-referenced to each other, clearly titled and show scale, orientation and date of execution;
- (b) drawings should not include any conjectural detail such as inaccessible elements that cannot be measured such as footings or framing;
- (c) the drawings can also be annotated or hatched to reveal more about the heritage significance of the site or object – to differentiate between dates of construction, materials and finishes;
- (d) record to the same standard all major fixtures such as machinery or building services; and
- (e) for industrial sites, recording the position, relationship and function of all fixtures, machinery and services is particularly important and maker's names, model numbers etc. should be included.

For further information refer to *Measure for Measure: A Practical Guide for Recording Buildings and Landscapes*, published by the RAlA in 1990.

(3) Requirements

A typical measured drawing package for a build structure should include:

- (a) location plan;
- (b) site plan (1:500 or 1:200);
- (c) floor plan/s (1:1:100 or 1:50) including basement or mezzanine levels;
- (d) roof plan/s (1:100 or 1:50);
- (e) elevations – showing all sides of the building (1:100 or 1:50);
- (f) sections – two sections, through the building in different planes (not parallel) (1:100 or 1:50);
- (g) ceiling and joinery details (1:20 or 1:10) – cornice, verandah posts, skirtings, mouldings;
- (h) other significant details (rainwater heads, construction joints); and
- (i) machinery and services details.

(4) Sheet sizes

Drawings should be on standard metric sheet sizes – A1, A2, A3 or A4.

**SC6.3.8.3 Interpretive signage for the loss of a heritage place**

In addition to archival recording, where a heritage place is to be lost, interpretive signage is to be provided. In particular:

- (1) the sign should be placed at the front of the property boundary, integrated with a wall or fence;
- (2) the sign should provide a photographic record and brief history of the heritage place;
- (3) the sign should have a 330 mm diameter, a 3 mm thick aluminium plate with weatherproofed finish, refer to Figure SC6.3.8.57; and
- (4) sign production i.e. colours used and branding should be consistent with the Townsville Heritage Trail Signage.



**Figure SC6.3.8.1 Illustrates an example of a desirable outcome, an example of a Heritage Trail sign (Flinders Street, Townsville)**

### SC6.3.9 Preparing an archaeological management plan

The following is advice for demonstrating achievement of performance outcome PO11 of the [Cultural heritage overlay code](#) associated with archaeology.

- (1) Any development with potential impact on archaeological values should provide for the following at a minimum:
  - (a) the potential impact on archaeological deposits on the site is to be monitored and assessed during earthworks by an appropriately qualified person;
  - (b) where archaeological deposits are identified, an archaeological management plan is to be prepared by an appropriately qualified person and approved to the satisfaction of the relevant authority, prior to the commencement of ground works; and
  - (c) any archaeological management plan that is prepared should follow best practice.

### SC6.3.10 Adding or removing a place from Schedule 7 Places of cultural heritage value

- (1) The places of cultural heritage value in Townsville are contained in [Schedule 7 Places of cultural heritage value](#) and overlay map [OM04.1 – OM04.4](#) of the Townsville City Plan. The process of entering and removing a heritage place from Schedule 7 and the overlay involves:
  - (a) identification;
  - (b) application;
  - (c) assessment; and
  - (d) notification.
  
- (2) Council assesses a place based on the place fulfilling one or more cultural heritage criteria listed below. There are approximately 325 places in Townsville that meet one or more of the cultural heritage criteria stated below. These places have been incorporated into Schedule 7 Places of cultural heritage value of the Townsville City Plan. The [Citation of Heritage Places Report](#) provides information about each heritage place in Townsville. It highlights the criteria that were originally identified for each place and indicates its heritage significance and eligibility for entry into Schedule 7 Places of cultural heritage value. It should be noted that a building, site or place may be entered into Schedule 7 Places of cultural heritage value of the Townsville City Plan if it meets one or more of the cultural heritage criteria listed below.
  - (a) It is important in demonstrating the evolution or pattern of Townsville's history.
  - (b) It demonstrates rare, uncommon or endangered aspects of Townsville's cultural heritage.

- (c) It has potential to yield information that will contribute to the knowledge and understanding of Townsville's history.
  - (d) It is important in demonstrating the principal characteristics of a particular class or classes of cultural places.
  - (e) It is important because of its aesthetic significance.
  - (f) It is important in demonstrating a high degree of creative or technological achievement at a particular period.
  - (g) It has a strong or special association with the life or work of a particular community or cultural group for social, cultural or spiritual reasons.
  - (h) It has a special association with the life or work of a particular person, group or organisation of importance in Townsville's history.
  - (i) It was constructed prior to 1910.
- (3) For a heritage place to be removed from Schedule 7 Places of cultural heritage value of the Townsville City Plan the applicant must highlight that there is evidence to sufficiently demonstrate that a place has no cultural heritage significance, based on the Criteria listed Schedule 7 Place of cultural heritage value in the Townsville City Plan.

Following the lodgement of the application form titled, "Application form to add or remove a place from Schedule 7 Places of cultural heritage value of the Townsville City Plan," council will make a decision as to whether to enter, not enter, or remove a place from Schedule 7 Places of cultural heritage value. It should be noted that if a place is nominated to be included on, or to be removed from Schedule 7 Places of cultural heritage value, council will be required to undertake an amendment to the Townsville City Plan as required by the [Planning Act 2016](#).

For more information refer to:

- (a) Application Guide: Entering a place to Schedule 7 Places of cultural heritage value.
- (b) Application Guide: Removing a place from Schedule 7 Places of cultural heritage value.
- (c) Application form to add or remove a place from Schedule 7 Places of cultural heritage value of the Townsville City Plan.